

## Self-service frame slicers

# NEW SELF

- ✓ Maximum safety due to the double cover being locked during the cutting cycle
- ✓ Removable, ergonomic crumb collector
- ✓ Automatic cutting cycle for simplicity of use
- ✓ Easy users guide
- ✓ Front bumper to protect the machine

Up to 250 loaves an hour

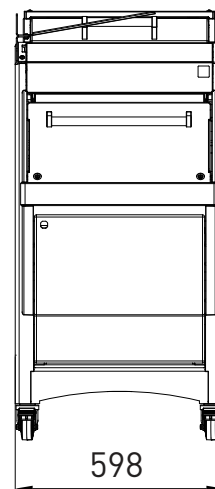
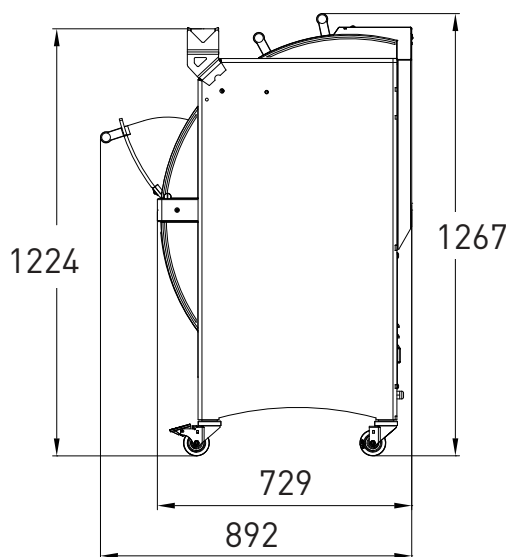



**Intelligent Slicing Concept (JAC patent)**  
Continuous automatic control system that slices loaves according to their consistency. This allows open textured, crusty and dense breads to be sliced with equal efficiency.



**JAC FIX**  
Holds the loaf together for easier handling at the exit of the slicer.



**Front safety cover**  
Locked during the slicing process for maximum safety.



**Removable crumb collector**  
Completely safe. Accessible by tilting the front door.  
25 litre capacity.



**Rear safety cover**  
Closing it initiates the slicing process and it remains mechanically and electrically locked during cutting.



**JAC STOP (JAC patent)**  
This patented system holds the bread slices together to facilitate handling.  
**Option suited to specific types of bread: contact JAC for details.**



**Type available "M" system**

Micronised knife lubrication system for cutting bread with a high rye content or sticky crumb. Developed by JAC, it consumes the least possible amount of oil (120 ml per 1000 loaves) and delivers consistent cutting quality.

**Option self service**  
**Tranchez votre pain vous-même, facilement et en toute sécurité.**

1. Ouvrir le couvercle.
2. Charger le pain.
3. Refermer le couvercle, le tranchage commence automatiquement.
4. En fin de coupe le pain s'entraine vers l'arrière sur une palette récupérant le pain tranché.

5. Sortir le pain de la machine, le pain se refroidit ensuite automatiquement.  
6. Finir de trancher le pain à l'aide de la palette d'emballage.

Contactez-nous pour plus d'informations.

Users explanatory notice

## FEATURES

	NEW SELF 450	NEW SELF 450M 
Max. loaf dimensions in cm (L x W x H)	44 x 31 x 16	44 x 30 x 16
Motor power in kW	0.49	1.1
Net weight (in kg)	210	220
Blade type and dimensions in mm	Steel 13 x 0.5	13 x 0.5, Teflon-coated
JAC FIX	•	•

## CHOICES

Slice thickness in mm	9 - 18	9 - 12
Loaf pusher height	Extra low (50mm) Low (80mm) High (100m)	Misch (80mm)
Type of motor	230V single phase 230V three-phase 400V three-phase	400V three-phase
Standard colour*	•	•

## OPTIONS

Heavy duty motor	•	
JAC STOP	•	•
Extra 4 cm height	•	•
Users explanatory notice	•	•
Daily adding counter	•	•
Special colour	•	•
Special blades	•	

\*STANDARD COLOURS

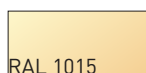

RAL 1015

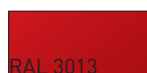

RAL 3013



RAL 9005

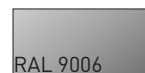

RAL 9006

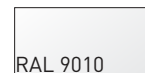

RAL 9010